











Warnings

-   Compressed size of image is less than 6.66667% of original size (1x on page 1)



Fixes

-   Changed trapped flag to "False"
-   Changed PDF/X version key to PDF/X-3:2002
-   Changed PDF/X-3:2002 Output Intent to Custom



Processing

Certified PDF status	Preflighted successfully
Preflight Profile	SpringerNature_Print_cover_V21_2021_12_07
Created by	Mark RübSam / Klaus Rüschoff Springer Nature
Pages processed	1
Application used to preflight	Enfocus PitStop Server 22 powered by Enfocus PitStop Library 22
Application used to create the report	Enfocus PitStop Library 22
Preflighted on	UTC: May 22, 2024 - 09:36:18 [May 22, 2024 - 15:06:18]

Document properties

Document Name	11814_41_6_Cover_PrintPDF.pdf
Number of pages	1
PDF Version	1.3
Creation Date	UTC: May 22, 2024 - 09:32:00 [May 22, 2024 - 15:02:00]
Modification Date	UTC: May 22, 2024 - 09:32:00 [May 22, 2024 - 15:02:00]
Producer	Acrobat Distiller 24.0 (Windows)
Creator	Adobe InDesign 15.1 (Windows)
Author	e504496
Title	11814_41_6_OC.indd
Subject	-
Keywords	-
Trapped	no
Trapping Information Present	no
Repaired on Open	no
Optimized for Fast Web View	yes
Thumbnails Present	no
Binding	left
Job Ticket Present	no

Security

Encryption Type	not encrypted
Content Copying or Extraction	allowed
Content Access for Disabled Users	allowed
Adding or Modifying Annotations	allowed
Creating or Modifying Form Fields	allowed
Form Field Fill-in or Signing	allowed
Document Assembly	allowed
Other Document Modifications	allowed
Printing	high resolution

Compression

Data format	binary
Document structure compressed	yes
Filters used	JPEG, ZIP



Status Incoming Document

Not Certified

Action:

Started Certified PDF workflow

Status Outgoing Document

Preflight Profile Name:	SpringerNature_Print_cover_V21_2021_12_07
Author:	Mark Rübsam / Klaus Rüschoff
Company:	Springer Nature
Document Status	Preflighted successfully
Preflight Profile Status	Match

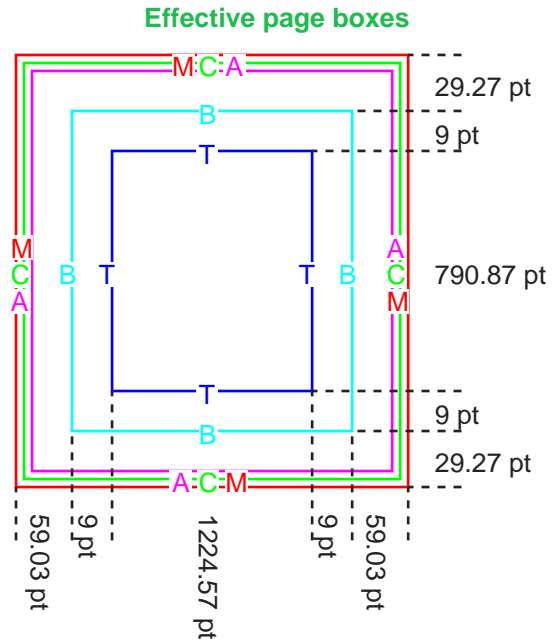
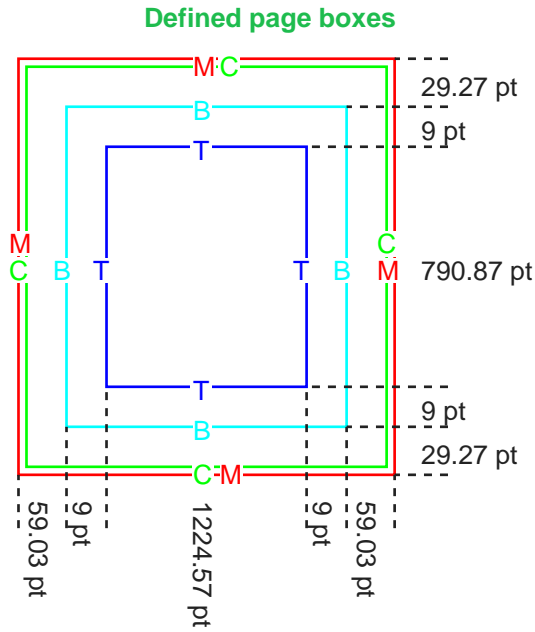

Page box	Defined size	Effective size
Media box (M)	1360.63 x 867.4 pt	1360.63 x 867.4 pt
Crop box (C)	1360.63 x 867.4 pt	1360.63 x 867.4 pt
Trim box (T)	1224.57 x 790.87 pt	1224.57 x 790.87 pt
Bleed box (B)	1242.57 x 808.87 pt	1242.57 x 808.87 pt
Art box (A)	not defined	1360.63 x 867.4 pt

Defined for page 1
 Media box starts at : (0, 0) pt
 Page rotation : 0 degrees
 Page scaling factor : 1



	PostScript font name	Type	Embedded as	Subset	Encoding
🔍	MyriadPro-BoldSemiCn	Type 1	Type 1	no	Custom
🔍	MyriadPro-Cond	Type 1	Type 1	no	Custom
🔍	MyriadPro-SemiCn	Type 1	Type 1	no	Custom
🔍	MyriadPro-SemiboldCond	Type 1	Type 1	no	Custom
🔍	MyriadPro-SemiboldSemiCn	Type 1	Type 1	no	Custom



Type	Color Space	Size (pixels)	Resolution (ppi)	Bits per channel	Page	Angle (degrees)	Shear	Flipped	Custom Transfer	Custom Halftone	Custom BG	Custom UCR
Color	CMYK	3217x4023	357.1x357.1	8	1	0	-	-	-	-	-	-



Item	Value
🔍 Color Space Page	CMYK 1
🔍 Color Space Page Name Alternate Space CMYK values	Separation (Registration color) 1 ■ All CMYK [1, 1, 1, 1]
🔍 Color Space Page Name Alternate Space CMYK values	Separation (Process color) 1 ■ Black CMYK [0, 0, 0, 1]



Document Output Intent

GTS_PDFX

Output condition	ISO Coated v2 300% (ECI)
Output condition identifier	Custom
Additional information	ISO Coated v2 300% (ECI)
Destination output profile	ISO Coated v2 300% (ECI)